

Pluto

2017 Price List

Pricing Effective June 2017

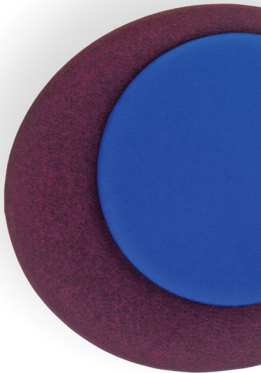
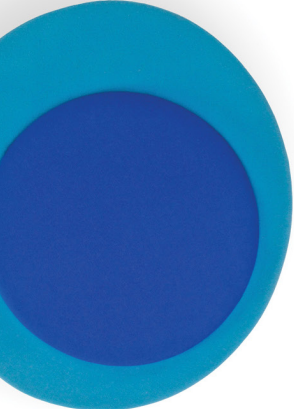
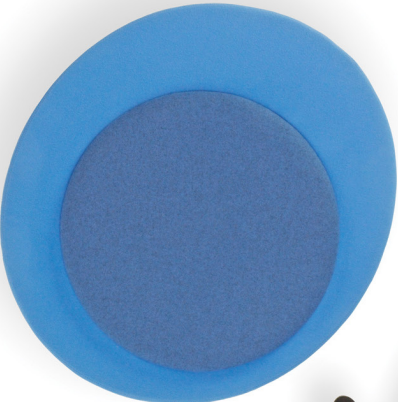

2017 PLUTO BENCH PRICE LIST

PLUTO BENCH: TABLE OF CONTENTS PB2
PLUTO BENCH SPECIFICATION INFORMATION PB3
PLUTO BENCH SPECIFICATION EXAMPLE PB4
PLUTO BENCH PB5
PLUTO AUXILIARY OPTION PB6

BENCH MODEL

DESCRIPTION	CODE
Pluto	PT

UPHOLSTERY SELECTION

Refer to Leland Textile Program featuring textiles from the following partners:

- Brentano
- Camira
- Carnegie
- CF Stinson
- Green Hides
- Maharam
- Unika Vaev

The complete grade list can be found at www.lelandinternational.com/ecatalog or you can specify COM. Due to the design of this product, it is recommended that all non pre-approved textile be tested for compatibility.

UPHOLSTERY REQUIREMENTS

With a choice of textile combinations, Pluto encourages design creativity. Please note that requirements vary by combination. The graded price of the combined yardage will be calculated using the highest grade textile selected.

TEXTILE REQUIREMENTS	YARDAGE
One textile, entire bench:	3.25 yards
Two/Three textile combination	
Seat:	1 yard
Top:	1 yard
Side:	1.25 yards

PLINTH FINISH: POWDER COAT AND CHROME

DESCRIPTION	CODE
Black	B
Chardonnay	CD
Cool Grey	CG
Java	JV
Matte Black	MB
Slate	S
Sterling	ST
Warm Grey	WG
White	W
Brushed Chrome	BC

AUXILIARY OPTION

Floor mount must be specified at the time of the bench order.

DESCRIPTION	CODE
Floor mount	PTFM

GLIDES

Pluto glides are poly.

SHIPMENT DETAIL

200 pounds of weight ballast is shipped separately from the Pluto bench and is required to be installed at the final delivery location.

SPECIFICATIONS REQUIRED TO CREATE THE PRODUCT CODE

- Model
- Seat Upholstery
- Top Upholstery
- Side Upholstery
- Plinth Finish
- Floor Mount (when applicable)



MODEL

Pluto (PT)

SEAT UPHOLSTERY

COM (COM)

TOP UPHOLSTERY

Grade D (D)

SIDE UPHOLSTERY

Grade D (D)

PLINTH FINISH

Brushed Chrome (BC)

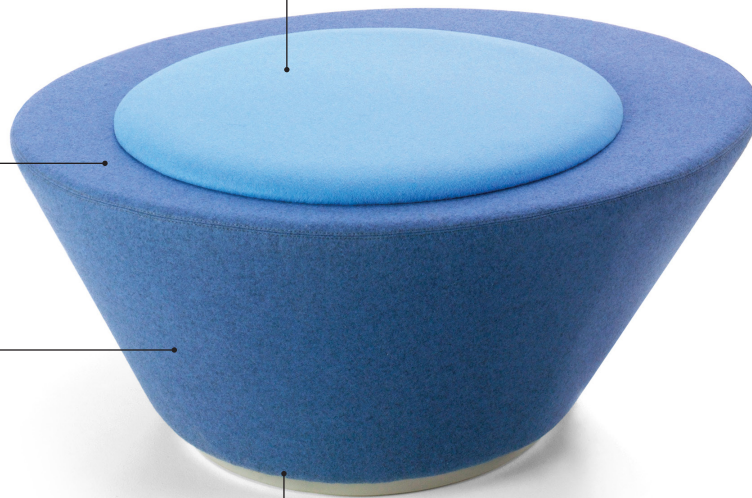

FLOOR MOUNT

When applicable, enter Pluto
Floor Mount Code

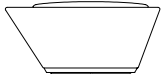

PLUTO BENCH

MODEL	LIST PRICE/GRADE	COM	A	B	C	D	E	F	G	H	I	J	K	L
PT-__		\$1179	1346	1430	1514	1598	1682	1766	1850	1934	2018	2102	2186	2270

powder coat plinth
W 34 D 37.75 H 16.5

COM REQUIREMENTS VARY BY COMBINATION SELECTED.

TEXTILE REQUIREMENTS	YARDAGE
One textile, entire bench:	3.25 yards
Two/Three textile combination	
Seat:	1 yard
Top:	1 yard
Side:	1.25 yards

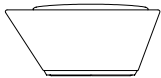

PLUTO BENCH

MODEL	LIST PRICE/GRADE	COM	A	B	C	D	E	F	G	H	I	J	K	L
PT-BC		\$1299	1466	1550	1634	1718	1802	1886	1970	2054	2138	2222	2306	2390

brushed chrome plinth
W 34 D 37.75 H 16.5

COM REQUIREMENTS VARY BY COMBINATION SELECTED.

TEXTILE REQUIREMENTS	YARDAGE
One textile, entire bench:	3.25 yards
Two/Three textile combination	
Seat:	1 yard
Top:	1 yard
Side:	1.25 yards

TO SPECIFY: Please refer to pages 3–4 for complete specifying information.
Specify all products by their product code.

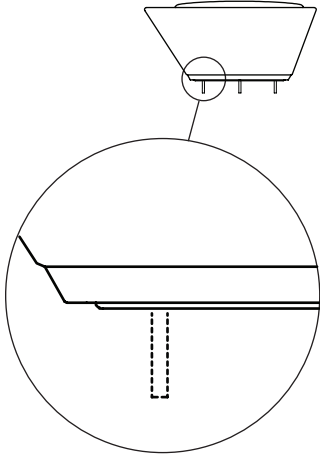

PLUTO FLOOR MOUNT

MODEL

LIST PRICE

PTFM

\$119

Due to the variety of floor surfaces on which the Pluto Bench may be installed, floor mount fasteners are not supplied by Leland International. The Pluto Bench floor mount feature consists of three .5" thru holes designed to use .3125" or .375" threaded studs. Leland International recommends at least 2" of exposed thread length from the floor surface.

Responsibility of fastener choice is the customers.

Floor Mount must be specified at the time of purchasing.

The Floor Mount cannot be added later in the field.

TO SPECIFY: Please refer to pages 3–4 for complete specifying information. Specify all products by their product code.